

OLIVER

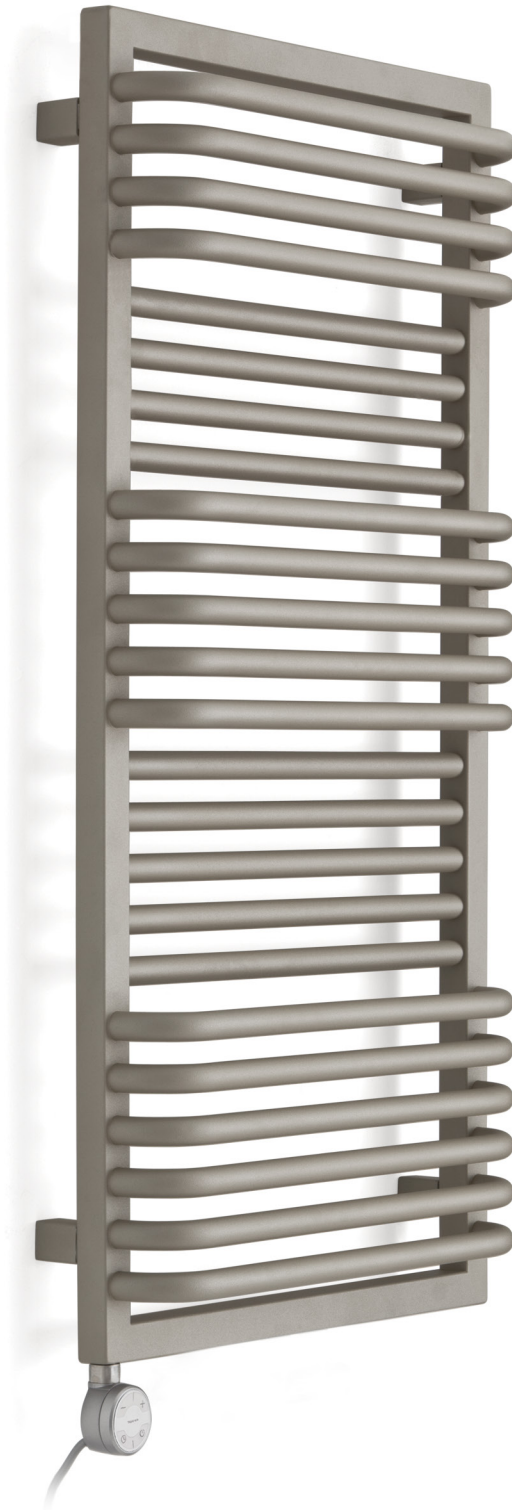

1040 x 500 E1
couleur : *california beige*

Kit résistances SOA, satin



Raccordements :

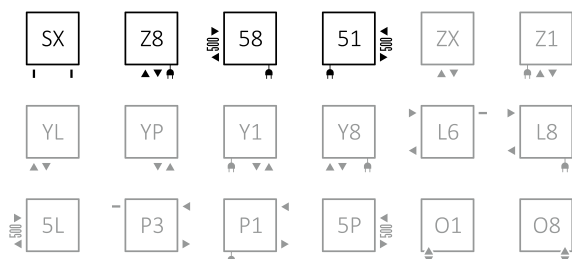

Version électrique :

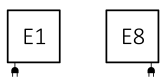

Recommandés :

Ensemble de réglage triaxe pour le raccordement SX



Rosette de masquage intégrée

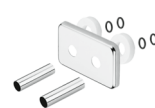

Kit résistances SOA



Données techniques :

Pression du travail : 1,0 MPa Température maximale de travail : 95°C

A ↓	B ↔	C1 [mm]	C2 [mm]	C5 [mm]	75/65/20°C [W]	55/45/20°C [W]	☺ [W]	D [mm]	E [mm]	F [mm]	U [dm³]	⚖️ [kg]	Code produit	Code de configuration p. 6
600	450	50	420	500	308	167	300	420	420	90	3,19	6,23	WGZUL060045	
600	500	50	470	500	342	185	400	470	420	90	3,45	6,78	WGZUL060050	
600	600	50	570	500	410	222	400	570	420	90	3,99	7,87	WGZUL060060	
840	450	50	420	500	443	239	400	420	660	90	4,29	8,42	WGZUL084045	
840	500	50	470	500	493	266	600	470	660	90	4,64	9,16	WGZUL084050	
840	600	50	570	500	590	318	600	570	660	90	5,36	10,64	WGZUL084060	
840	700	50	670	500	690	372	800	670	660	90	6,07	12,11	WGZUL084070	
1040	450	50	420	500	556	299	600	420	860	90	5,26	10,38	WGZUL104045	
1040	500	50	470	500	618	332	600	470	860	90	5,70	11,28	WGZUL104050	
1040	600	50	570	500	743	399	800	570	860	90	6,56	13,07	WGZUL104060	
1040	700	50	670	500	866	465	800	670	860	90	7,42	14,87	WGZUL104070	
1240	450	50	420	500	669	359	800	420	1060	90	6,19	12,22	WGZUL124045	
1240	500	50	470	500	744	399	800	470	1060	90	6,70	13,28	WGZUL124050	
1240	600	50	570	500	893	479	1000	570	1060	90	7,71	15,40	WGZUL124060	
1240	700	50	670	500	1041	559	1000	670	1060	90	8,72	17,51	WGZUL124070	
1400	500	50	470	500	844	452	800	470	1220	90	7,53	14,96	WGZUL140050	
1400	600	50	570	500	1013	543	1000	570	1220	90	8,66	17,34	WGZUL140060	
1400	700	50	670	500	1182	633	1200	670	1220	90	9,79	19,71	WGZUL140070	



Dimensions dis-

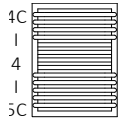

600 x 450

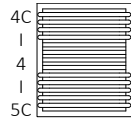

600 x 500

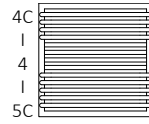

600 x 600

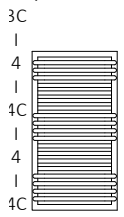

840 x 450

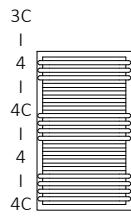

840 x 500

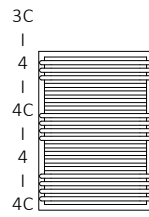

840 x 600

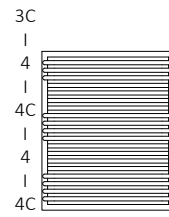

840 x 700

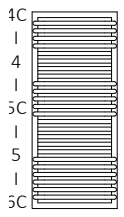

1040 x 450

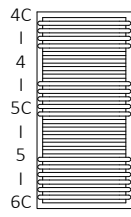

1040 x 500

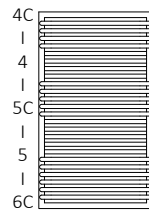

1040 x 600

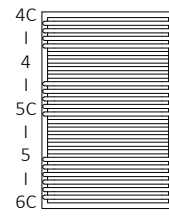

1040 x 700

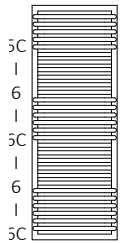

1240 x 450

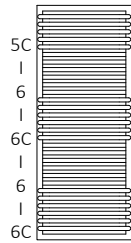

1240 x 500

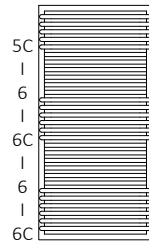

1240 x 600

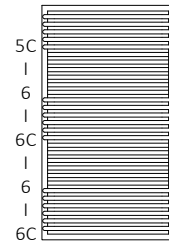

1240 x 700

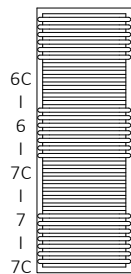

1400 x 500

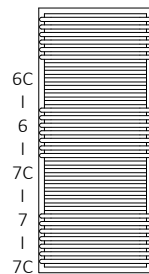

1400 x 600

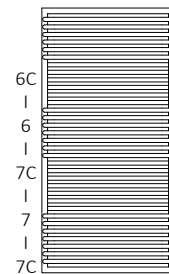

1400 x 700



SX

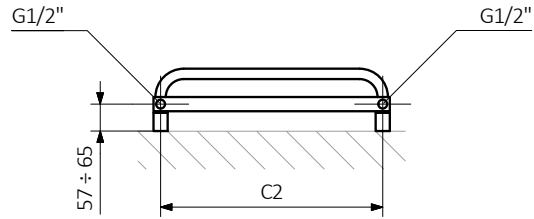

51

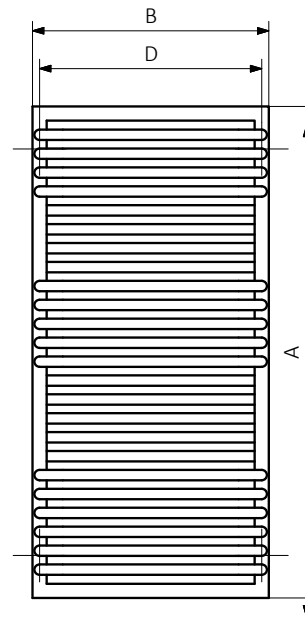
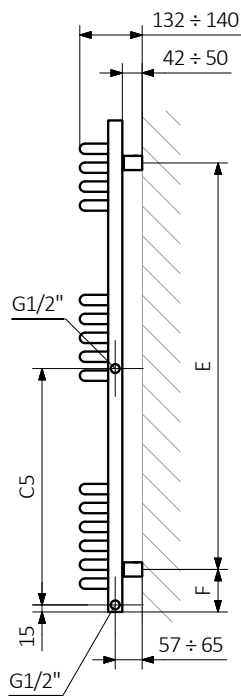
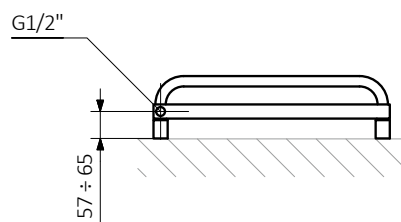

A – hauteur B – largeur C1-C5 – écartement des raccords D – écartement des consoles en horizontal E – écartement des consoles en vertical F – distance de l'axe de la console inférieure au bord inférieur du collecteur

Collecteur :

Profil :

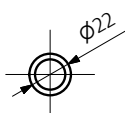
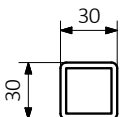

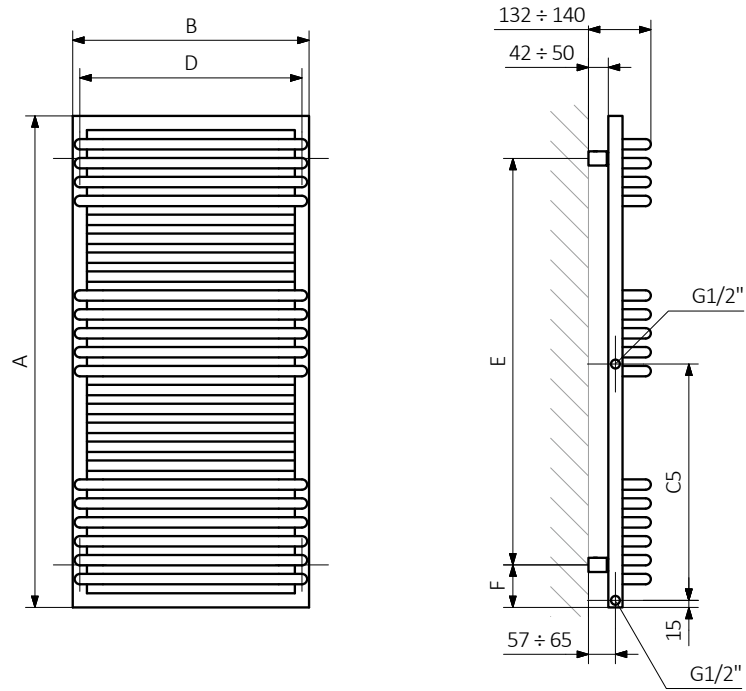
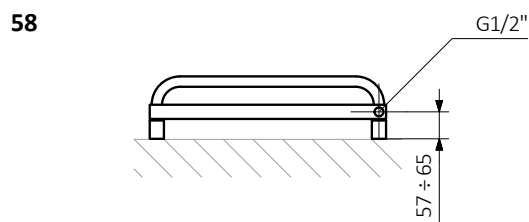
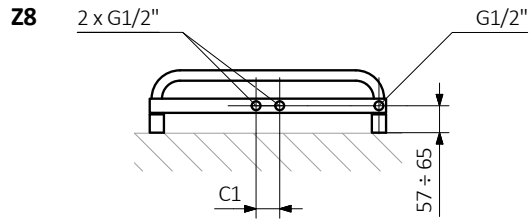

A – hauteur B – largeur C1-C5 – écartement des raccordements D – écartement des consoles en horizontal E – écartement des consoles en vertical F – distance de l'axe de la console inférieure au bord inférieur du collecteur

Collecteur :

Profil :

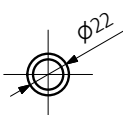
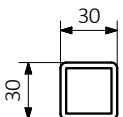



Des cartes techniques des produits contiennent des codes qui indiquent des informations de base sur des produits. Afin de préciser les caractéristiques du produit, des codes devraient être complétés par un code de configuration complète. Code de configuration doit suivre le code produit comme dans l'exemple ci dessous :

Construction du code de configuration du radiateur eau chaude et électrique :

WGALE054030

K916SX

CODE PRODUIT
(indiqué dans la grille à côté du produit)

CODE DE CONFIRGURATION
(à remplir)

Configuration

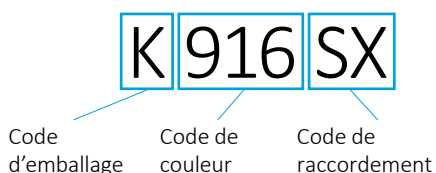

K – carton

Construction du code de configuration du radiateur électrique :

WLALE054030

K916E1DRYM

CODE PRODUIT
(indiqué dans la grille à côté du produit)

CODE DE CONFIRGURATION
(à remplir)

Configuration



K – carton

Couche en poudre de zinc

C – Code de la couche en poudre de zinc est rempli dans le code atypique.

WLALE054030 K916SX **C** — Code atypique



Légende



Radiateur disponible en finition chromée.



Radiateur disponible en version hydraulique.



Radiateur disponible en version mixte. Possibilité d'installation du kit résistances.



Radiateur disponible en version électrique avec le kit résistances. Version électrique est remplie par le fabricant du fluide caloporteur et équipée du kit résistances électrique. Radiateur testé en usine.



Type de raccordement dédié au modèle choisi. L'icône indique le positionnement du raccordement hydraulique départ et retour ainsi que le positionnement de la cartouche thermostatique et du kit résistances à positionner.



Type de raccordement optionnel pour le modèle donné.



Puissance suggérée du kit résistance pour la version électrique ou mixte.



Poids.



Volume.